

KRTW 20B

White light contrast scanner Advanced

en 03-2011/02 50112368



13,5mm

- White light transmitter
- Various teach variants
- Short response time
- Switching threshold adjustment via EasyTune
- Level adaptation for glossy objects
- Keyboard lockout
- Remote teach via cable
- Pulse stretching
- YellowBoost for improved color difference detection

Dimensioned drawing

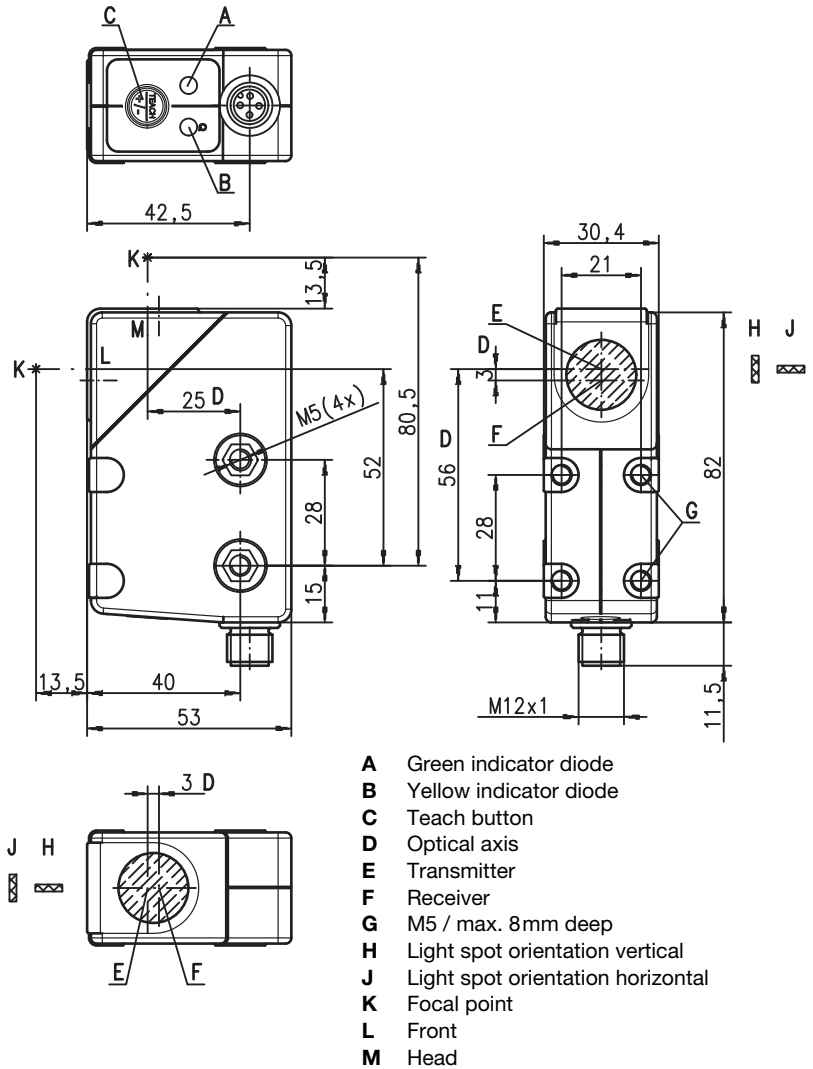

Electrical connection

Plug connection, 4-pin

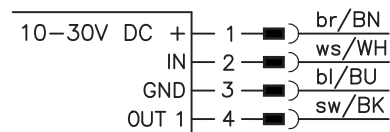

We reserve the right to make changes • DS_KRTW_Ad_20B_en.fm

Accessories:

(available separately)

- Cable with M12 connector (K-D ...)

Specifications

Optical data

Scanning range ¹⁾	13,5mm ± 3 mm (from housing front edge)
Light spot dimensions	in RUN-Mode 1.5mm x 4mm (at a distance of 13,5mm) in Teach-Mode 1.5mm x 4mm (at a distance of 13,5mm)
Optical outlet	front or head (see dimensioned drawing)
Light spot orientation	vertical or horizontal (see dimensioned drawing)
Light source ²⁾	LEDs (red, green, blue)
Wavelength	640nm, 525nm, 470nm

Timing of the sensor

Internal switching frequency	10kHz
Internal response time	50µs
Response jitter, internal	20µs
Repeatability ³⁾	0.02mm
Delay before start-up	≤ 300ms
Conveyor speed during teach	≤ 0.1 m/s for a mark width of 1 mm
Teach process	static 2-point or dynamic 2-point
Teach delay	≤ 10ms

Electrical data

Operating voltage U _B ⁴⁾	10 ... 30VDC (incl. residual ripple)
Residual ripple	≤ 15% of U _B
Output/function	.../2... Pin 4: GND if mark is detected .../4... Pin 4: U _B if mark is detected
Signal voltage high/low	≥ (U _B -2V)/≤ 2V
Output current	max. 100mA
Open-circuit current	≤ 25mA

Indicators

Green LED in continuous light	ready
Green and yellow LED flashing at 3Hz	teach event active
Green and yellow LED flashing at 8Hz	teaching error
Green LED off and yellow LED flashing at 8Hz	sensor error
Yellow LED in continuous light	mark detected (dependent on the teach sequence)
Transmitter LEDs flashing at 8Hz	teaching error

Mechanical data

Front mount	M5, Stainless steel, (AISI 316L), penetration depth max. 5.5mm, max. tightening torque = 2Nm
Through-hole mount	M5, glass fiber reinforced, max. tightening torque = 2Nm
Optics cover	glass
Weight	50g
Connection type	M12 connector, 4-pin

Environmental data

Ambient temp. (operation/storage)	-30 °C ... +55 °C/-30 °C ... +70 °C
Protective circuit ⁵⁾	2, 3
VDE safety class	II
Protection class	IP 67
LED class	1 (acc. to EN 62471)
Standards applied	IEC 60947-5-2
Certifications	UL 508 ⁴⁾

Options

Input pin 2	
Function characteristics	keyboard lockout / line teach / pulse stretching
Input active/not active	≥ 8V/≤ 2V or not connected
Output pin 4	
Line-teach active	2Hz at switching output
Error after line-teach	2Hz at switching output

- 1) Scanning range: recommended range with performance reserve
- 2) Average life expectancy 100,000h at an ambient temperature of 25 °C
- 3) At conveyor speed 1 m/s
- 4) For UL applications: for use in class 2 circuits according to NEC only
- 5) 2=polarity reversal protection, 3=short-circuit protection for all transistor outputs

Tables

Diagrams

Remarks

- **Approved purpose:**
This product may only be used by qualified personnel and must only be used for the approved purpose. This sensor is not a safety sensor and is not to be used for the protection of persons..
- With glossy objects, the sensor is to be fastened at an inclination of approx. 10° relative to the object surface.

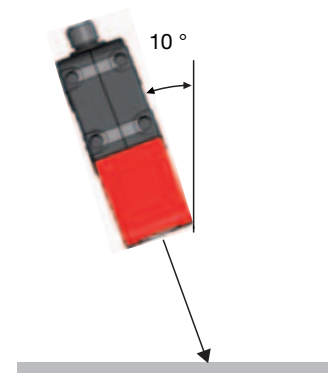

KRTW 20B

White light contrast scanner Advanced





Order guide

Selection table		Order code →				
Equipment ↓		KRTW 20B/4.4121-S12 Part No. 50111621	KRTW 20B/2.4121-S12 Part No. 50111623	KRTW 20B/4.5121-S12 Part No. 50111622	KRTW 20B/2.5121-S12 Part No. 50111624	KRTW 20B/4.6121-S12 Part No. 50111770
Transmitter color	white light	●	●	●	●	●
	RGB (red, green, blue)					
Optical outlet	front			●	●	
	head	●	●			●
Light spot orientation	vertical	●	●	●	●	
	horizontal					●
Output (OUT 1)	PNP transistor output	●		●		●
	NPN transistor output		●		●	
	push-pull switching output					
	IO-Link COM2					
Input (IN)	teach input	●	●	●	●	●
Teach process	static 1-point					
	static 2-point	●	●	●	●	●
	dynamic 2-point					
Response time / Switching	50 μs / 10 kHz	●	●	●	●	●
	83 μs / 6 kHz					
Configuration	switching threshold adjustment with EasyTune via teach button	●	●	●	●	●
	remote teach, keyboard lockout and pulse stretching via pin 2	●	●	●	●	●
	teach level 1, teach-level 2 and pulse stretching via teach button	●	●	●	●	●



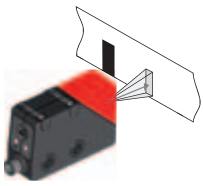

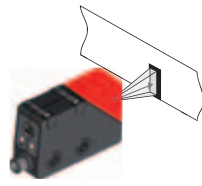
Static 2-point teach

Suitable for manual positioning of the marks (availability dependent on sensor type).

Switching threshold in center:

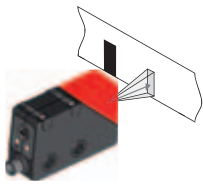
<p>Position the background.</p> 	<p>Press teach button for 2 ... 7s and release.</p>  <p>2 ... 7s Value for background is accepted.</p>	<p>LEDs flash simultaneously.</p>  <p>Simultaneous flashing</p>	<p>Position the mark.</p> 	<p>Briefly press teach button.</p>  <p>Value for mark is accepted.</p>	<p>Sensor in RUN mode. Yellow LED illuminates.</p>  <p>Switching threshold set in the center.</p>
---	--	---	---	---	--

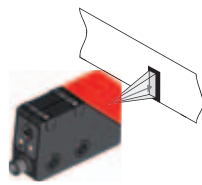



Switching threshold near the mark:

<p>Position the background.</p> 	<p>Press teach button for 7 ... 12s and release.</p>  <p>7 ... 12s Value for background is accepted.</p>	<p>LEDs flash alternatingly.</p>  <p>Alternating flashing</p>	<p>Position the mark.</p> 	<p>Briefly press teach button.</p>  <p>Value for mark is accepted.</p>	<p>Sensor in RUN mode. Yellow LED illuminates.</p>  <p>Switching threshold is set near the mark.</p>
---	--	---	---	---	---



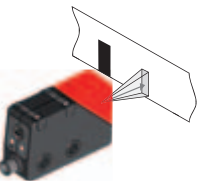

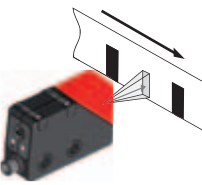
Dynamic 2-point teach

Suitable for marks moved during automated machine processes (availability dependent on sensor type).

Switching threshold in center

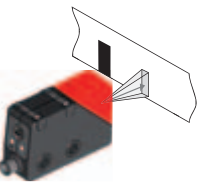
<p>Position the background.</p> 	<p>Press teach button for 2 ... 7s and release.</p>  <p>2 ... 7s Measurement window opens.</p>	<p>LEDs flash simultaneously.</p>  <p>Simultaneous flashing</p>	<p>Allow marks to pass through dynamically.</p> 	<p>Briefly press teach button.</p>  <p>Measurement window closes.</p>	<p>Sensor in RUN mode. Yellow LED is off.</p>  <p>Switching threshold set in the center.</p>
---	--	---	---	--	---

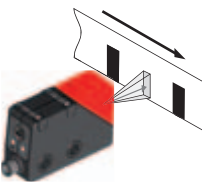
Switching threshold near the mark

<p>Position the background.</p> 	<p>Press teach button for 7 ... 12s and release.</p>  <p>7 ... 12s Measurement window opens.</p>	<p>LEDs flash alternatingly.</p>  <p>Alternating flashing</p>	<p>Allow marks to pass through dynamically.</p> 	<p>Briefly press teach button.</p>  <p>Measurement window closes.</p>	<p>Sensor in RUN mode. Yellow LED is off.</p>  <p>Switching threshold is set near the mark.</p>
---	--	---	---	--	--

Switching threshold diagrams

Static 2-point teach

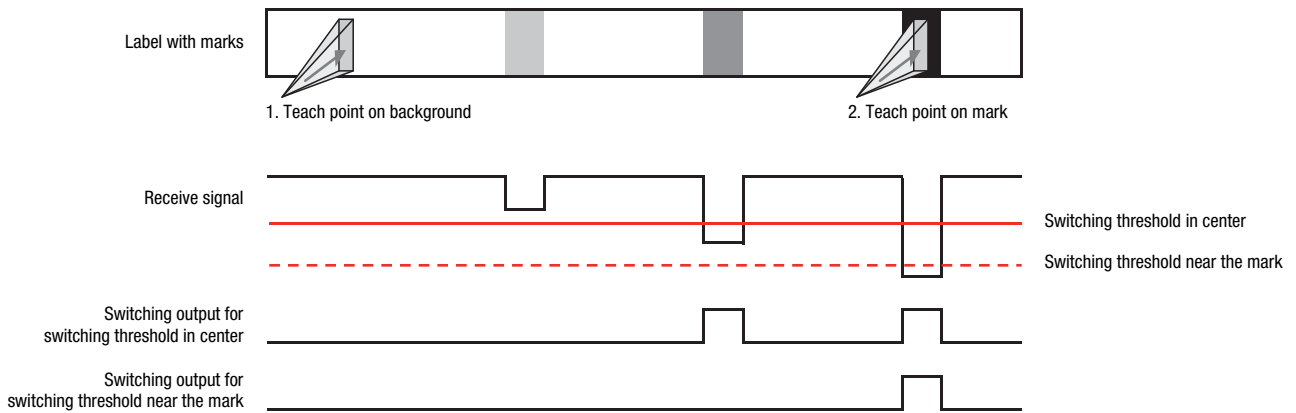

Dynamic 2-point teach

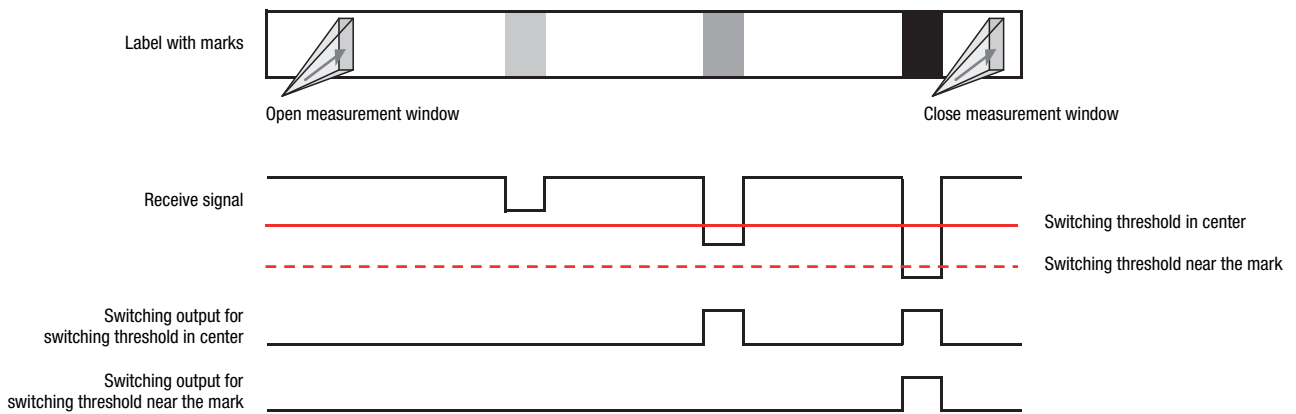

Pulse stretching option

Switching pulse stretching on or off:

Press the teach button longer than 12s.

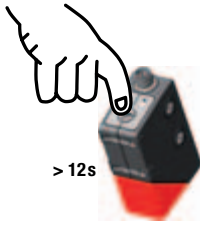

> 12s

Only the green LED flashes.



Release teach button.



Change is displayed and accepted automatically after 2s. Sensor in RUN mode.



after 2s



After 2s the yellow LED is back to normal operation, displaying the state of the switching output.

After releasing the teach button, the yellow LED displays the new pulse stretching status for 2s:
 yellow LED on: pulse stretching ON
 yellow LED off: pulse stretching OFF

"EasyTune" option - fine tuning of the switching threshold

Following power-on and completed teach event:

Green LED illuminates continuously (ready)

Yellow LED on/off continuously (mark detected/not detected)

Increasing the switching threshold:

Long press of the button = large force expenditure = increase switching threshold

Each press of the button with a duration between 200ms and 2s increments the switching threshold.

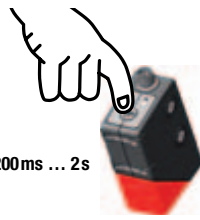

200ms ... 2s



Green LED flashes briefly once

A press of the button is acknowledged by a single, brief flash of the green LED – the new switching threshold is now valid.

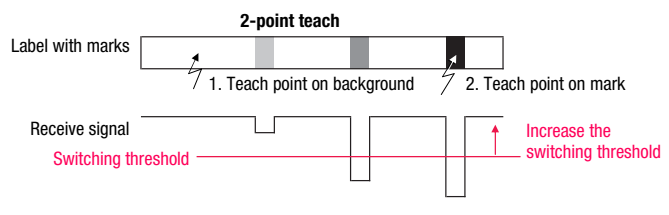

2-point teach

Label with marks

1. Teach point on background

2. Teach point on mark

Receive signal

Switching threshold

Increase the switching threshold

Reducing the switching threshold:

Short press of the button = small force expenditure = reduce switching threshold

Each press of the button with a duration between 2ms and 200ms decrements the switching threshold.

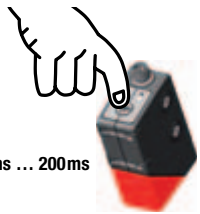

2ms ... 200ms



Green LED flashes briefly once

A press of the button is acknowledged by a single, brief flash of the green LED – the new switching threshold is now valid.

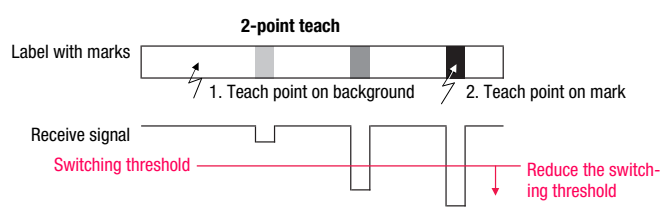

2-point teach

Label with marks

1. Teach point on background

2. Teach point on mark

Receive signal

Switching threshold

Reduce the switching threshold



If the upper or lower end of the adjustment range is reached, the green and yellow LEDs flash at a considerably higher frequency of 8Hz for the duration of one second.

Sensor adjustments via the input IN (Pin 2)



The following description applies to PNP switching logic!

Signal level LOW $\leq 2V$

Signal level HIGH $\geq (U_B - 2V)$

With the NPN models, the signal levels are inverted!

Switching threshold in center / standard sensitivity

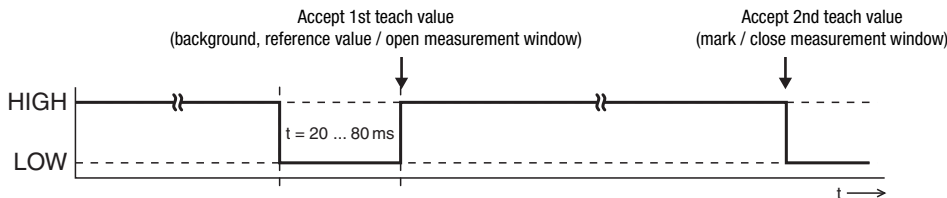

Switching threshold near the mark / high sensitivity

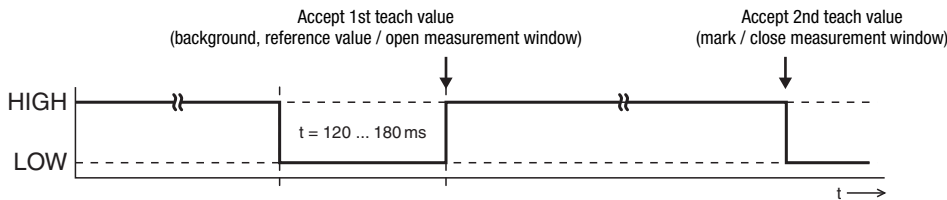

Pulse stretching ON

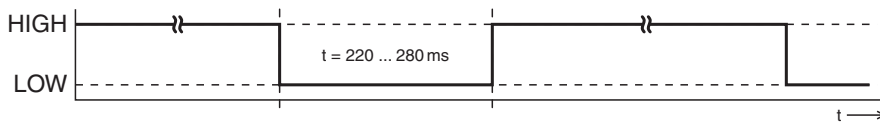

Pulse stretching OFF

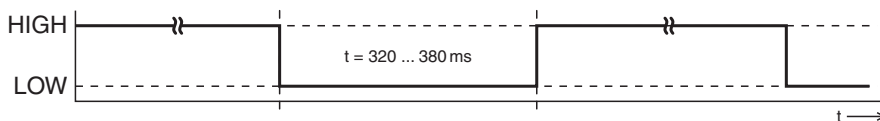

Locking the teach button via the input IN (Pin 2)



A **static HIGH signal** ($\geq 20ms$) at the teach input locks the teach button on the sensor if required, such that no manual operation is possible (e.g., protection from erroneous operation or manipulation).

If the teach input is not connected or if there is a static low signal, the button is unlocked and can be operated freely.

