

HRTR 3B "S"

Diffuse reflection light scanner with background suppression

en 10-2010/04 50107307



5 ... 200mm
100mm with
black-white error < 5%



- Diffuse reflection light scanner with visible red light and adjustable background suppression
- Small, homogenous light spot for detecting small parts
- Excellent black/white behavior and reliable switching, even on glossy objects and objects with colored structure
- Exact scanning range adjustment through 8-turn potentiometer
- Small and compact construction with robust plastic housing, protection class IP 67/IP 69K for industrial application
- A²LS- Active Ambient Light Suppression
- Push-pull switching outputs
- High switching frequency for detection of fast events

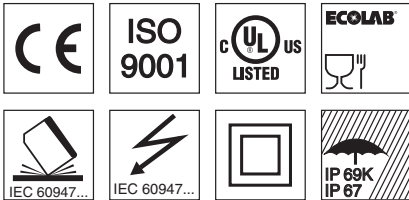

Accessories:

(available separately)

- Mounting systems (BT 3...)
- Cable with M8 or M12 connector (K-D ...)

Dimensioned drawing

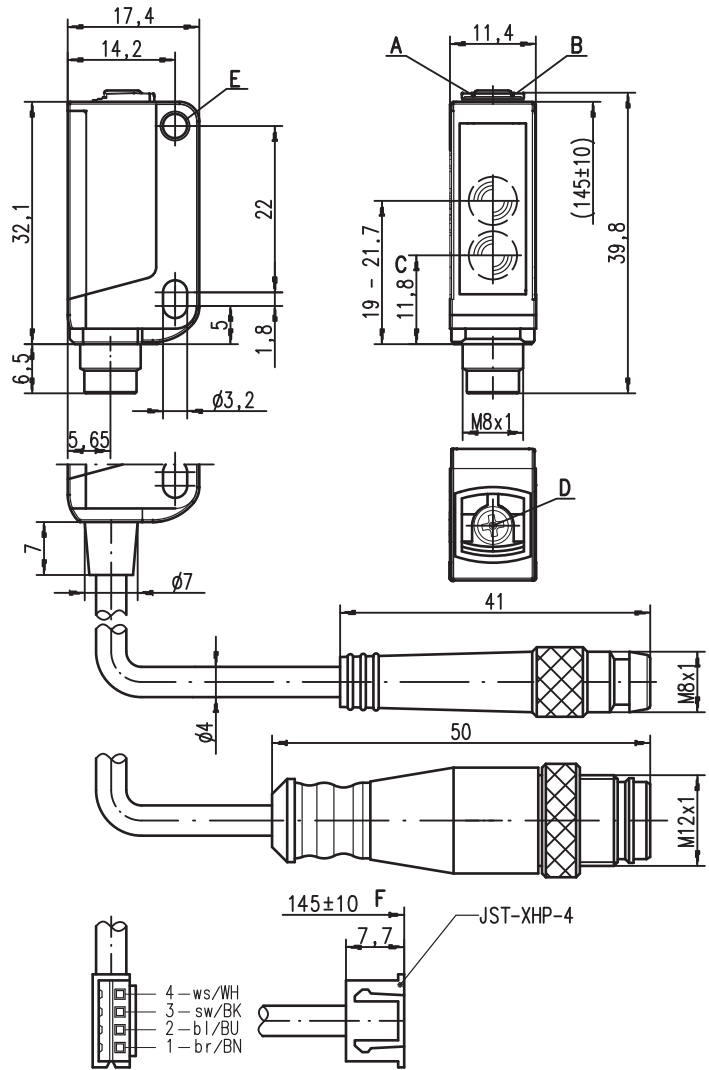

- A** Green indicator diode
- B** Yellow indicator diode
- C** Optical axis
- D** 8-turn potentiometer for scanning range adjustment
- E** Attachment sleeve
- F** Dimension, incl. device

Electrical connection

Plug connection, 4-pin

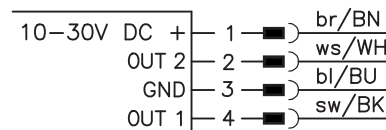

Cable, 4-wire

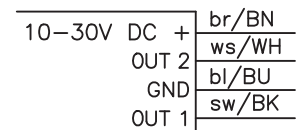

Plug connection, 3-pin

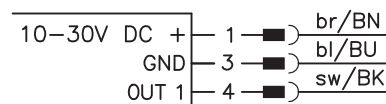

We reserve the right to make changes • DS_HRTR3B_S_en.fm

Specifications

Optical data

Typ. scanning range limit ¹⁾	5 ... 200mm
Scanning range ²⁾	see tables
Adjustment range ¹⁾	15 ... 200mm
Light spot	approx. Ø 4mm at 100mm
Light source ³⁾	LED (modulated light)
Wavelength	660nm (visible red light)

Timing

Switching frequency	1,000Hz
Response time	0.5ms
Delay before start-up	≤ 300ms (acc. to. IEC 60947-5-2)

Electrical data

Operating voltage U_B ⁴⁾	10 ... 30VDC (incl. residual ripple)
Residual ripple	≤ 15% of U_B
Open-circuit current	≤ 15mA
Switching output	2 push-pull switching outputs
...	pin 2: PNP dark switching, NPN light switching
...	pin 4: PNP light switching, NPN dark switching
...	1 push-pull switching output
...	pin 4: PNP light switching, NPN dark switching
...	1 push-pull switching output
...	pin 4: PNP dark switching, NPN light switching
...	1 PNP switching output light switching,
...	pin 2: not connected ⁶⁾

Function characteristics	light/dark switching
Signal voltage high/low	$\geq (U_B - 2V) \leq 2V$
Output current	max. 100mA
Scanning range	adjustable via 8-turn potentiometer

Indicators

Green LED	ready
Yellow LED	object detected - reflection

Mechanical data

Housing	plastic (PC-ABS); 1 attachment sleeve, nickel-plated steel
Optics cover	plastic (PMMA)
Weight	with connector: 10g with 200mm cable and connector: 20g with 2m cable: 50g
Connection type	2m cable (cross section 4x0.20mm ²), connector M8 metal, 0.2m cable with connector M8 or M12

Environmental data

Ambient temp. (operation/storage)	-30°C ... +55°C / -30°C ... +70°C
Protective circuit ⁷⁾	2, 3
VDE safety class	II for cable ⁸⁾ , III for metal plug
Protection class	IP 67, IP 69K
LED class	1 (acc. to EN 60825-1)
Standards applied	IEC 60947-5-2
Certifications	UL 508 ⁴⁾

- 1) Typ. scan. range limit/adjustment range: max. achievable scanning range/adjustment range for light objects (white 90%)
- 2) Scanning range: recommended scanning range for objects with different diffuse reflection
- 3) Average life expectancy 100,000h at an ambient temperature of 25°C
- 4) Observe the safety regulations and installation instructions regarding power supply and wiring;
for UL applications: only for use in "Class 2" circuits acc. to NEC
- 5) The push-pull switching outputs must not be connected in parallel
- 6) Pin 2: unassigned, hence especially suitable for the connection to AS-interface I/O coupling modules
- 7) 2=polarity reversal protection, 3=short-circuit protection for all transistor outputs
- 8) Rating voltage 50V

Remarks

Adapter plate: BT 3.2 (Part No. 501 03844) for alternate mounting on 25.4mm hole spacing (Omron E3Z, Sick W100...)

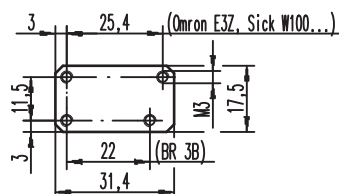

Tables

1	5	200
2	10	150
3	15	120

1	white 90%
2	grey 18%
3	black 6%

Scanning range [mm]

Diagrams

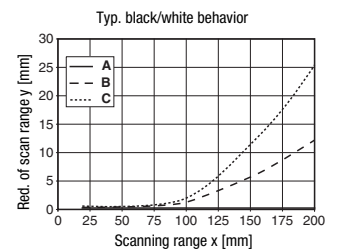
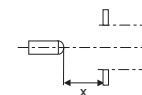
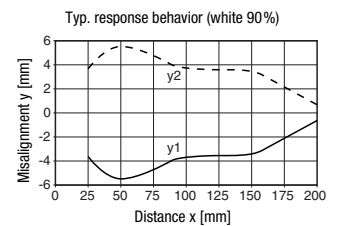

- A white 90%
- B grey 18%
- C black 6%

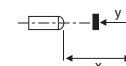

Remarks







Mounting system:



- ① = BT 3 (Part No. 500 60511)
- ②+③ = BT 3.1 ¹⁾ (Part No. 501 05585)
- ①+②+③ = BT 3B (Part No. 501 05546)

1)Packaging unit: PU = 10 pcs.

HRTR 3B "S"
Diffuse reflection light scanner with background suppression
Order guide

Selection table				Order code →	HRTR 3B/66-S Part No. 50107242	HRTR 3B/66-S-S8 Part No. 50107243	HRTR 3B/66-S, 200-S8 Part No. 50107244	HRTR 3B/66-S, 200-S12 Part No. 50107245	HRTR 3B/66-S, 5000 Part No. 50110809	HRTR 3B/6-S, S8.3 Part No. 50108407	HRTR 3B/6D-S-S8.3 on request	HRTR 3B/6-S, 200-S8.3 Part No. 50109051	HRTR 3B/6D-S, 200-S8.3 on request	HRTR 3B/66-S, 100-XHP Part No. 50113044	
Equipment ↓															
Output 1 (OUT 1)	push-pull switching output		light switching	○	●	●	●	●	●	●		●		●	
			dark switching	●							●		●		
	PNP transistor output		light switching	○											
			dark switching	●											
	NPN transistor output		light switching	○											
			dark switching	●											
Output 2 (OUT 2)	push-pull switching output		light switching	○											
			dark switching	●	●	●	●	●							●
	PNP transistor output		light switching	○											
			dark switching	●											
	NPN transistor output		light switching	○											
			dark switching	●											
Connection	cable 100mm		4-wire											● ¹⁾	
	cable 2,000mm		4-wire	●											
	cable 5,000mm		4-wire					●						●	
	M8 connector, metal		3-pin						●	●					
	M8 connector, metal		4-pin		●										
	200mm cable with M8 connector		3-pin									●	●		
	200mm cable with M8 connector		4-pin			●									
	200mm cable with M12 connector		4-pin				●								
	pin 2: not assigned, suitable for connecting to AS-i coupling module									●	●	●	●		
Configuration	freely adjustable via 8-turn potentiometer			●	●	●	●	●	●	●	●	●	●	●	
	preset to scanning range [mm]:														

1) With XHP connector: dimensions including device 145mm ± 10mm

Application notes



- **Approved purpose:**

The light scanners are optical electronic sensors for optical, contactless detection of objects.

This product may only be used by qualified personnel and must only be used for the approved purpose. This sensor is not a safety sensor and is not to be used for the protection of persons.

- For glossy surfaces (e.g. metals), the light beam should not be incident on the object surface at a right angle. A slight inclination is sufficient for preventing undesired direct reflections. This may result in a reduction in the scanning range.
- Objects should only be moved in laterally from the right or left. Moving in objects from the connector side or operating side is to be avoided.
- Outside of the scanning range, the sensor operates as an energetic diffuse reflection light scanner. Light objects can still be reliably detected up to the scanning range limit.
- The sensors are equipped with effective measures for the maximum avoidance of mutual interference should they be mounted opposite one another. Opposite mounting of multiple sensors of the same type should, however, absolutely be avoided.