

Part No. 601932



Device Mounting Column

The UPM40-1800-S2 Device Mounting Columns are used for the freestanding mounting of Multiple Light Beam Safety Devices, Safety Light Curtains and UM60 Deflecting Mirrors. They enable a precise vertical and axial alignment.

Features Dimensional drawing

- Automatic resetting following mechanical impacts through special spring elements in the column base
- Complete mounting set for floor fixing included with delivery
- Easy installation, quick vertical and axial alignment in just a few steps

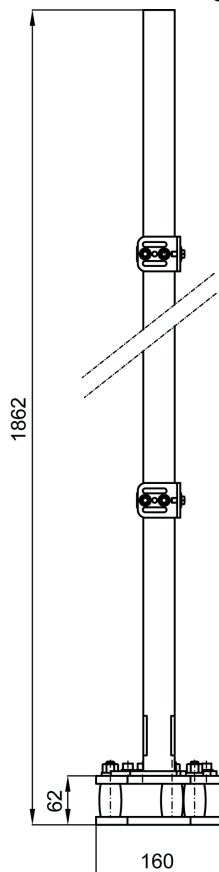

Mounting

Necessary parts and tools:

- Allen key: 5 mm, 6 mm
- Hexagon wrench: 16 mm, 17 mm
- Bubble level
- Drill with 10 mm masonry drill bit
- LA-78U Laser Alignment Aid (recommended for multisided safeguards and large operating ranges)

Work steps:

11. Use the base plate to determine the mounting midpoint of the column and make a mark on the floor.
12. Starting from the midpoint, draw approximately 90 mm long connecting lines on the floor.
13. Place the drilling template on the midpoint, align with the connecting lines and mark the bore holes.
14. Drill fastening holes 80 mm deep and insert floor anchors

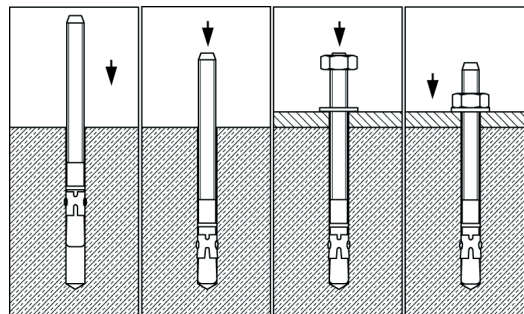

15. Position the columns, screw down and, with the aid of the bubble level, tighten the adjustment screws (a) to align vertically.

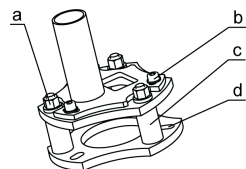

- a = Adjustment screws
- b = Allen screws
- c = Plastic spring element with automatic resetting
- d = 3 bore holes for floor anchors, Ø 10 mm

16. Push the two provided clamp brackets onto the column tube from above and lightly secure the height appropriately for devices that are to be mounted. In doing so, leave space above and below the clamp brackets to fasten the Laser Alignment Aid on the device.
17. Screw the device to the lateral groove on the mount of the clamp brackets.
18. Perform the electrical connection of the device and switch on.
19. Position the Laser Alignment Aids above and below each device (transmitter and receiver) and switch on.
20. Check the alignment of the device and correct if necessary. Optimum alignment is achieved when the weak beam indicator of the receiver is off.

Ordering information

Part No.	Article	Description
909967	UPM40-1800-S2	Device Mounting Column incl. accessories
560020	LA-78U	Laser Alignment Aid for COMPACT, COMPACTplus, ROBUST and UM60
549604	BT-2UPM40	2 clamp brackets for 40 mm tube

We reserve the right to make changes